



bajadesigns®
THE SCIENTISTS OF LIGHTING

**Can-Am Maverick R Bumper Kits
(44-8203 & 44-8214 - 44-8222)**



2950 Norman Strasse San Marcos, CA 92069

Phone 760-560-2252 X3 • Fax 760-560-0383

info@bajadesigns.com • www.bajadesigns.com



baja designs[®]
THE SCIENTISTS OF LIGHTING

LIMITED LIFETIME WARRANTY

Baja Designs proudly offers a LIFETIME WARRANTY against manufacturer's defect on all the products that we manufacture.

These are comprehensive warranties; other than the exclusions below – you're covered. If your LED or HID bulb burns out, you're covered. Additionally, cutting off our connector or changing your lenses does not automatically void your warranty.

Exclusions:

Installation errors, abuse, misuse, or crash damage. You must be the original owner of the product and can supply proof of purchase.

Baja Designs manufactures its own products as well as resells products manufactured by others. Baja Designs makes no express or implied warranties on products not manufactured by Baja Designs including without limitation any warranties or merchantability and fitness for a purpose. We will, however, pass on all warranties made by the manufacturer, who has sole responsibility for performing such warranties.

Baja Designs will pay the freight if your product is less than 90 days old, otherwise defective products must be returned to Baja Designs, Inc., freight prepaid. At our option, we will repair or replace items in question and return them at no charge. If the identical product is no longer available, we will replace it with a similar product of equal value. Baja Designs Inc. will not be responsible for any indirect or consequential damages in connection with defective merchandise.

Items purchased through a Baja Designs authorized dealer must be returned through the dealer. Only available on LED auxiliary lights and product must be in sellable condition at MSRP. Product that has been damaged in any way after the original purchase date will be excluded from this guarantee.

Indemnification:

Buyer hereby acknowledges off-roading, racing and driving at night are dangerous activities and that the products and/or supplies purchased from Baja Designs are used in an inherently dangerous activity that may endanger life and limb; and in no event shall the seller, or seller's heirs and assigns, be held liable for consequential damages, nor shall seller's liability on any claim for damages arising out of or connected with the sale, delivery, or use of purchased products and/or supplies exceed the purchase price of the products and/or supplies.













Buyer is responsible for ensuring that it uses the products (and its vehicle) in accordance with all applicable laws, regulations, guidelines, and standards of care. Buyer acknowledges that some products may only be used when off-roading, and Buyer will comply with all vehicle and road safety guidelines. Buyer is solely responsible for (and will indemnify and hold Bestop harmless for) any claims, losses, damages, fines, fees, costs, or other amounts arising out of Buyer's non-compliance with these provisions.

***For a color copy of instructions, visit your vehicle specific application on BajaDesigns.com ***

Required Tool(s):

- Sockets: 17mm deep socket, 17mm shallow socket, 9/16", 7/16"
- Wrenches: 17mm, 9/16", 7/16"
- Misc: 4mm Hex tool, flush cutter, trim removal tool

Parts List:

 <p>(20-1009) (QTY: 4) Hardware, M10-1.5x25mm Long Bolt</p>	 <p>(20-1024) (QTY: 8) Hardware, 10mm Flat Washer</p>	 <p>(20-1499) (QTY: 4) Hardware, M10 x 1.5 mm Thread SS Nylon Insert Locknut</p>	 <p>(20-1612) (QTY: 5) Hardware, Zip Tie 50lb 8"</p>
 <p>(65-0215) (QTY: 3) Parts Bag, SQ/S2 Single, For Kits</p> <p>Squadron Kits ONLY</p>	 <p>(61-3607) (QTY: 1) Squadron/S2 Wire Harness Splitter- adds 1 light</p> <p>Squadron Kits ONLY</p>	 <p>(64-0312) (QTY: 1) Wiring Harness, Can-Am, Maverick R, Squadron/S2/S1 2- Light</p> <p>Squadron Kits ONLY</p>	 <p>(64-0311) (QTY: 1) Wiring Harness, Can-Am, Maverick R, LP4 A-Pillar Kit Harness</p> <p>LP4 Kits ONLY</p>
 <p>(64-0313) (QTY: 1) Wiring Harness, Can-Am, Maverick R, S8/OnX6/Linkable Harness</p> <p>ONX6+/XL Kits ONLY</p>	 <p>(61-3608) (QTY: 1) OnX6/S8/XL (Pro & Sport) Wire Harness Splitter</p> <p>XL Kits ONLY</p>	 <p>(64-0320) (QTY: 2) 4-Pin Deutsch 5' Extension</p> <p>LP4 Kits ONLY</p>	 <p>(64-0321) (QTY: 1) Wiring Harness, Can-Am, Maverick R, Dual LP6 Bumper Harness</p> <p>LP6 Kits ONLY</p>



(55-9003) (QTY: 3)
Squadron Sport,
Driving/Combo LED, For Kits

Squadron Kits ONLY



(44-9419) (QTY: 1)
Can-Am, Maverick
R, Pre-Runner
Bumper
**Pre-runner
bumper kits ONLY**



(44-9421) (QTY: 1)
Can-Am, Maverick R, Push Bar
Bumper

Push Bar bumper kits only



(50-7803) (QTY: 1)
XL Pro, Pair
Driving/Combo LED

XL Kits Only



(29-7803) (QTY: 1)
LP4 Pro, Pair Driving/Combo
LED

LP4 Kits ONLY



(27-0003) (QTY: 2)
LP6 Pro, LED,
Driving/Combo

LP6 Kits ONLY



(45-1003) (QTY: 1)
OnX6+, 10" Driving/Combo LED
Light Bar

ONX6+ Kits Only

To begin, make sure the vehicle is in park, on level ground and the parking brake is engaged.

Step 1: Bumper Installation

Mock-up the bumper as seen below.



Step 2: Lower hardware installation

Install the 4X M10 bolts, 8X washers and 4X nuts at the 4X mounting locations using a 17mm shallow socket (Top two), 17mm deep socket (bottom two) and a 17mm wrench. Tighten all bolts evenly. Access the inboard side of the bolt by using the access holes (A) shown below.

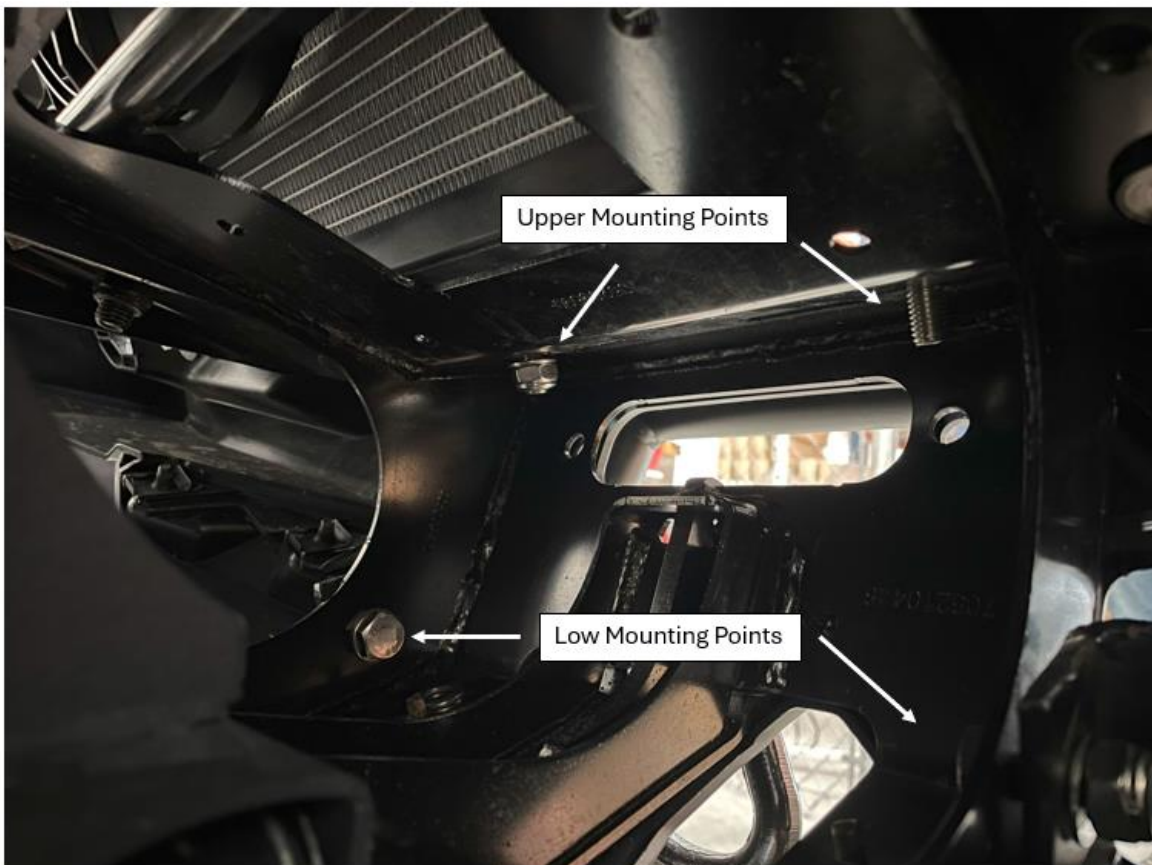



Step 3: Light Installation

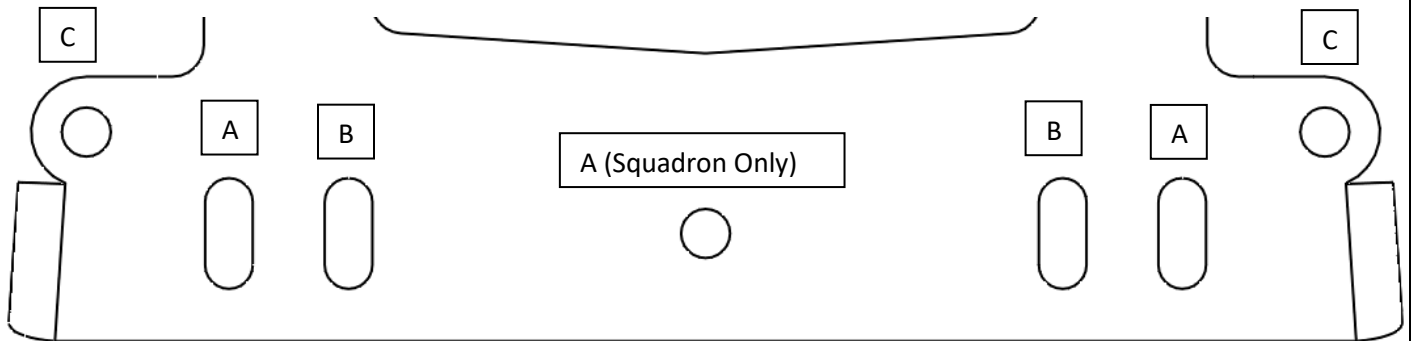

Install your 3X Squadron lights at locations A.

Install your 2X XL Lights at locations A or B.

Install your 2X LP6 Lights or 2X LP4 Lights at locations A except for the center position.

Install your 10" OnX6+ Light bar at locations C (see step 6 for details).

For best performance use the additional hardware provided with your light to lock the rotation of your light using A or B.

Step 4: ONX6+ Installation ONLY

Install the mounting brackets onto your OnX6+ light bar in a reverse configuration (see image below) with only the two front bolts (1) using a 7/16 socket (as shown below). Loosely install your assembly at location C using the hardware provided with your light. Swivel the light bar until it faces downward to tighten the rear mounting feet (2) using a 9/16" deep socket w/ extension and 9/16" wrench. Now swivel your light back into place and install the rear bolts using a 7/16" socket.

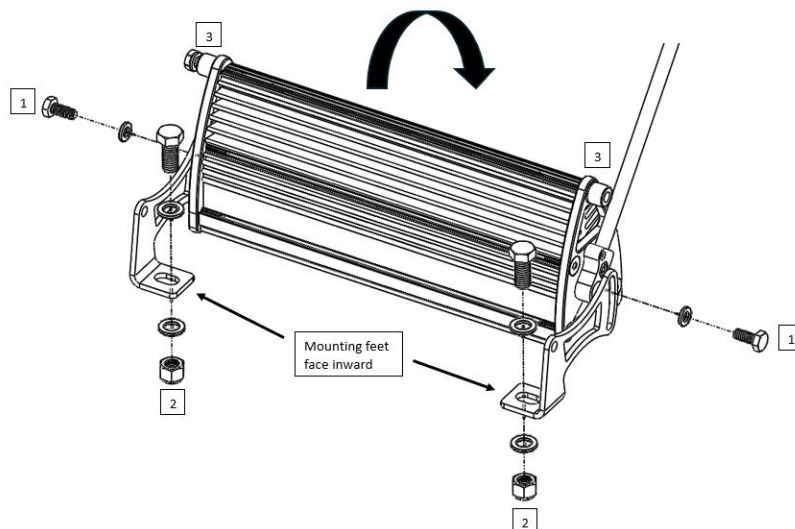

Step 5: Remove Fuse Box Cover

Remove Fuse Box Cover by pulling up on the latch.

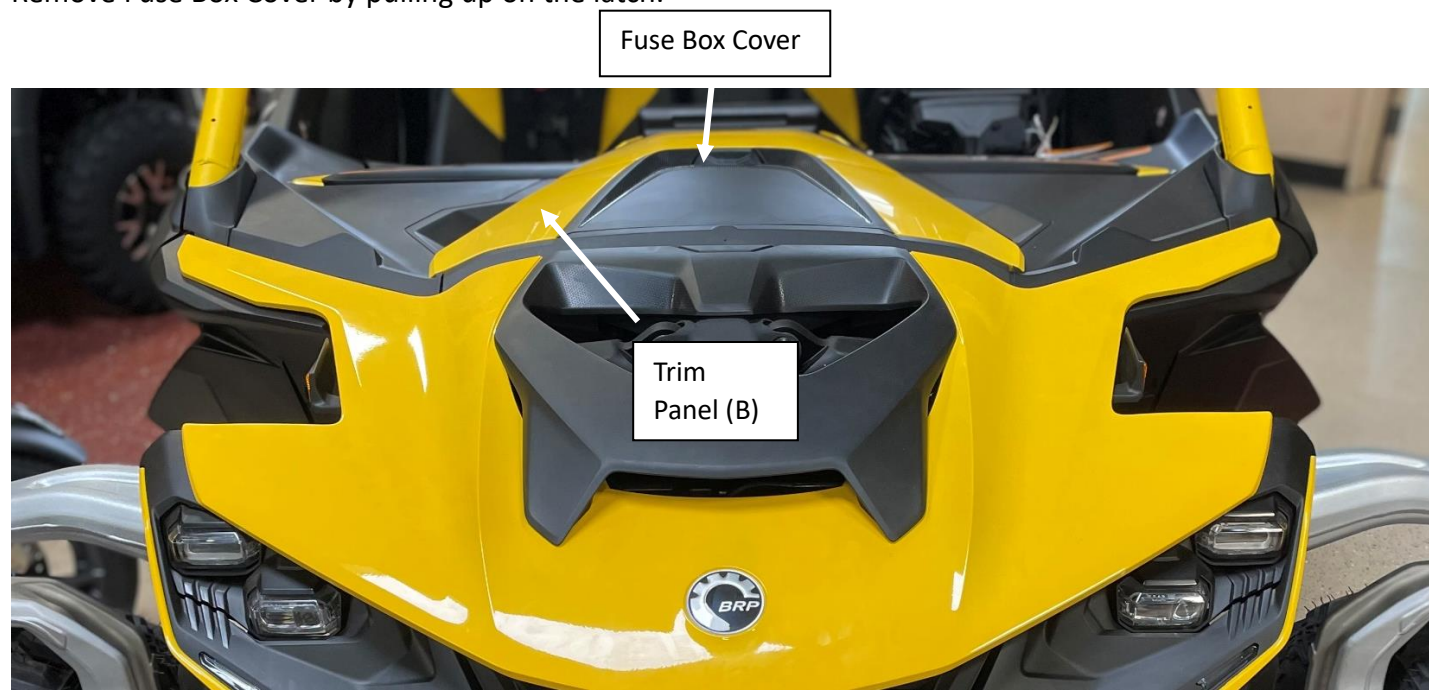

Step 6: Remove trim panels (B)

Remove the trim panel (B) on the passenger side of the fuse box cover by pulling straight up firmly. (Clip locations circled)

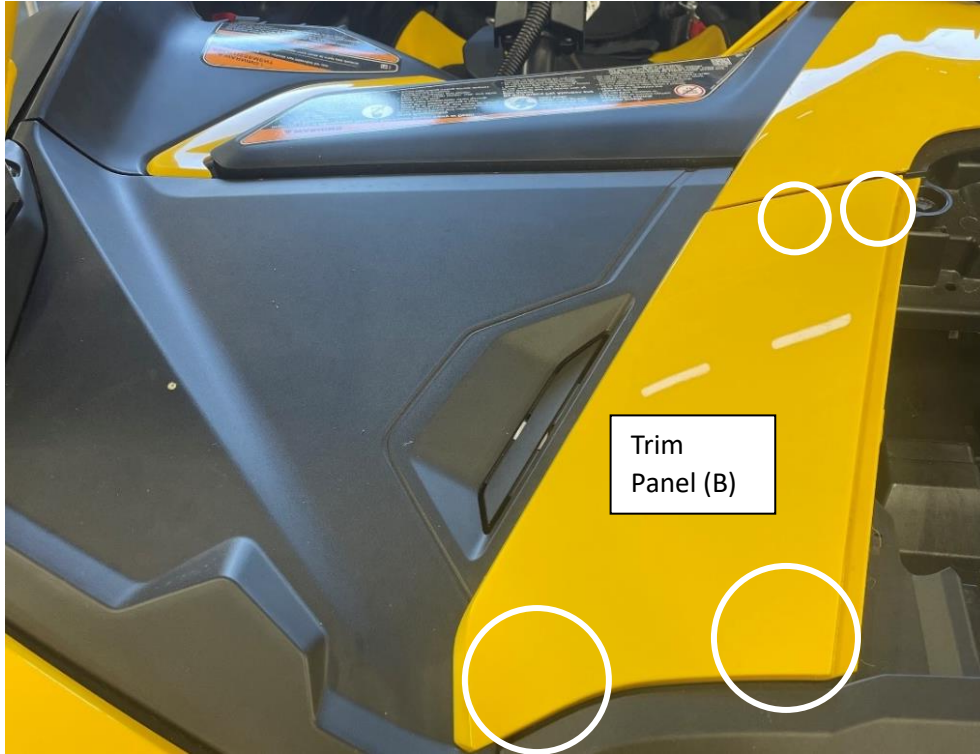

Step 7: Secure Wire Harness

Secure the wire harness under the fuse box cover using zip ties.

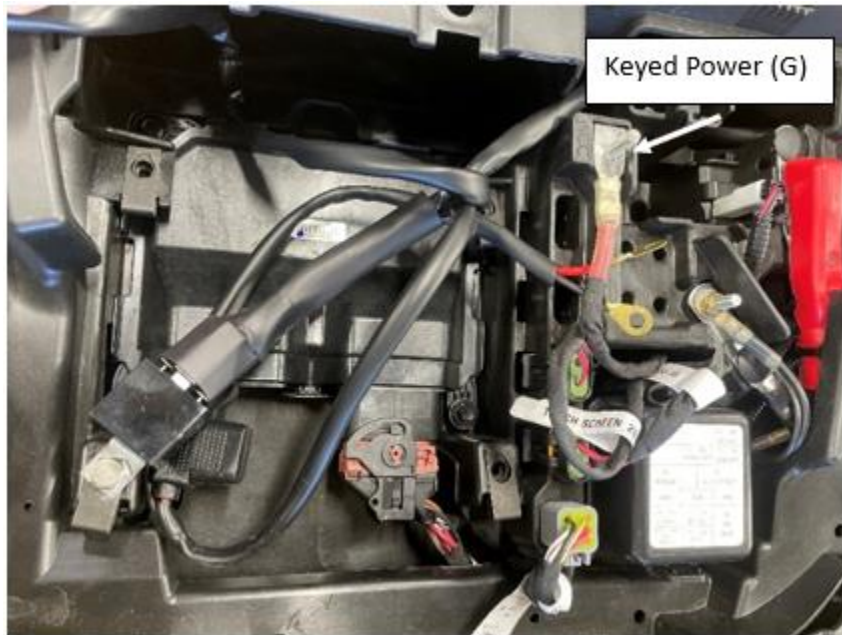

Step 8: Route harness as shown. DO NOT attach connector onto exposed wire harness pins if it is not already attached.

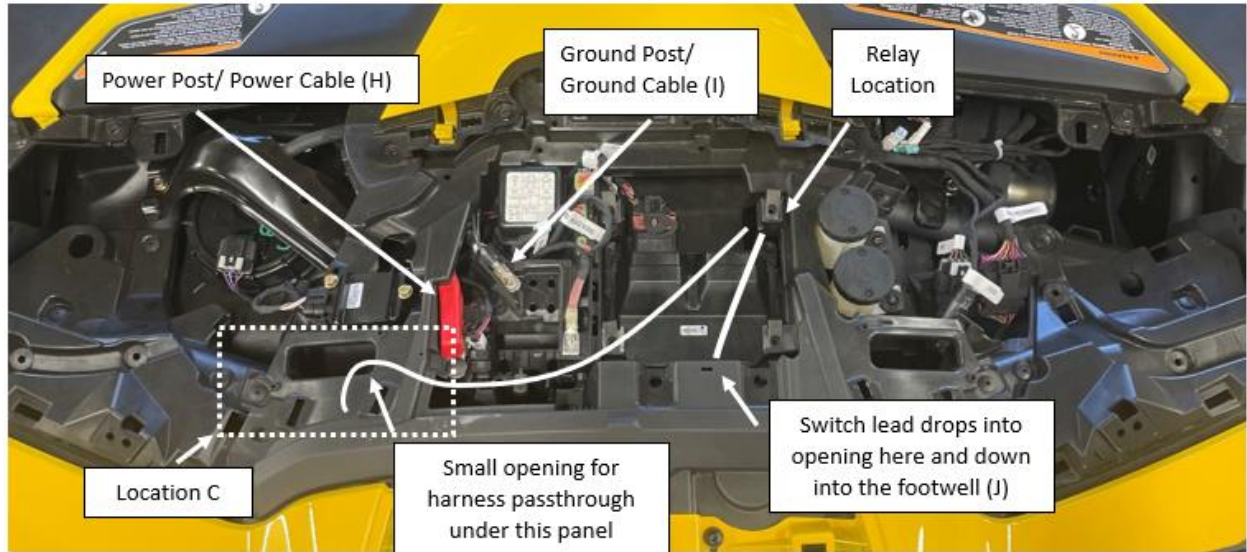

Step 9: Connector passthrough to the wheel well

Pass the connector lead through the opening specified below.



Step 10: Harness route from wheel well to vehicle front

Run the harness through the wheel well down to the tube members and along the frame to the front of the vehicle. Zip tie harness to the tube members and away from suspension/moving/hot components.



Step 11: Pinning info.

OnX6+/XL/Squadron ONLY

OnX6+/XL connector is labeled with A-B-C

Squadron connector is labeled with A-B

LP series is labeled 1-2-3-4

The pinout is as follows

A- Black/Ground

B- White/ Power

C- Green (Disregard for Squadron kits)

LP series pinout is as follows:

1- Red (High Beam)

2- Black (Ground)

3- Yellow (Backlight)

4- White (Low beam for LP6 Only)

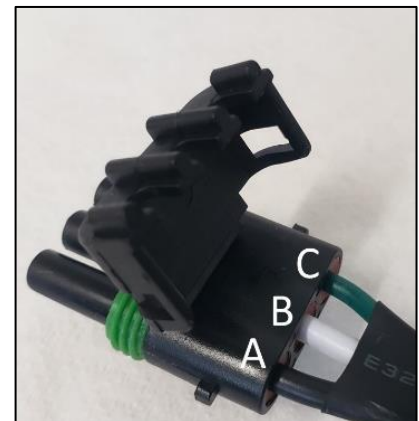

Step 12: Connect your harness to your lights

LP Series Lights ONLY

Pull the harness through the gap between the frame and the radiator. Plug the harness into the lights and tie away all loose wires using the provided zip ties. (LP4 kits may need to use extensions which are provided.)

XL, ONX6+, Squadron configurations:

Plug the harness into the power cords on the lights and tie away any slack with the zip ties provided. (Triple squadron kits and dual XL kits will need to use the splitter provided)

Step 13: Harness route from footwell to center switch panel

Run the switch lead through the footwell and under the center dashboard. See Step 8 Location (J) for footwell passthrough opening.



Step 14: Prep switch panel location

Remove the center switch panel by gently pulling it out of the dash panel. Pull the harness out from the exposed opening.



Step 15: Remove the blank(s) from the switch panel.

Remove the blanks by squeezing the prong tabs on each side together and pushing the blank(s) out.

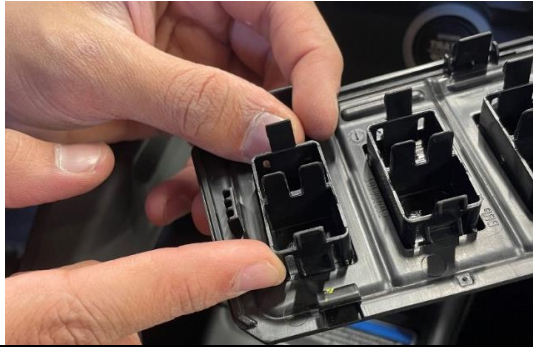

Step 16: Prep wire harness

Remove the rocker switch from the receiver and pass the receiver through the empty blank location.

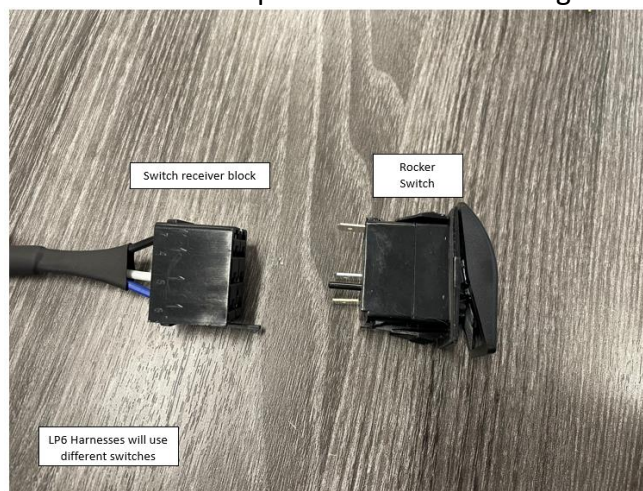

Step 17: Install Rocker Switch(s) onto the switch panel.

Re-install the switch onto the receiver through the top of the switch panel. Orientate the switch such that the blue indicator lens is in the top half.



Step 18: Connect Harness to accessory power

Connect the red ring terminal from the harness to post (H). Connect the black ring terminal from the harness to post (I). See step 8 for locations.

XL and ONX6+ ONLY

Remove the ring terminal on the green wire and instead attach the provided heat shrunk end. Tie away any slack.

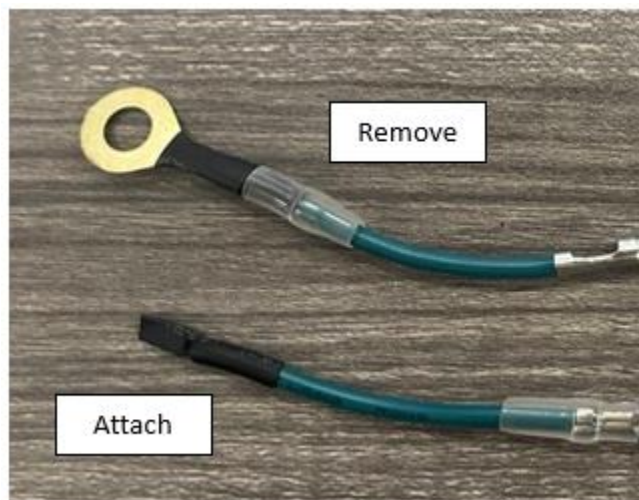
**LP6 and LP4 ONLY**

For backlight functionality connect the ring terminal on the yellow wire to keyed power as seen in step 7. Tie away any slack.

Step 19: Test light functionality

Test light functionality and confirm backlight activates when the vehicle is running (LP series only)

Installation complete!

*Tie all wires away from sharp, hot, and/or rotating components.

* Re-torque all the fasteners after 100 miles.

*Your install is now complete! Thank you for choosing Baja Designs.